

**REPORTE TÉCNICO DECRETO SUPREMO N°38/11 DEL MINISTERIO DEL MEDIO AMBIENTE**

Establece Norma de Emisión de Ruidos Generados por Fuentes que Indica

**FICHA DE INFORMACIÓN DE MEDICIÓN DE RUIDO**

**IDENTIFICACIÓN DE LA FUENTE EMISORA DE RUIDO**

Nombre o razón social	Globar Center Irarrázaval		
RUT	65.124.402-1		
Dirección	Irarrázaval 2401		
Comuna	Ñuñoa		
Nombre de Zona de emplazamiento (según IPT vigente)	Zona Z-1B		
Datum	WGS84	Huso	19s
Coordenada Norte	6.297.129	Coordenada Este	350.732

**CARACTERIZACIÓN DE LA FUENTE EMISORA DE RUIDO**

Actividad Productiva	<input type="checkbox"/> Industrial	<input type="checkbox"/> Agrícola	<input type="checkbox"/> Extracción	<input type="checkbox"/> Otro
Actividad Comercial	<input type="checkbox"/> Restaurant	<input type="checkbox"/> Taller Mecánico	<input checked="" type="checkbox"/> Local Comercial	<input type="checkbox"/> Otro
Actividad Esparcimiento	<input type="checkbox"/> Discoteca	<input type="checkbox"/> Recinto Deportivo	<input type="checkbox"/> Cultura	<input type="checkbox"/> Otro
Actividad de Servicio	<input type="checkbox"/> Religioso	<input type="checkbox"/> Salud	<input type="checkbox"/> Comunitario	<input type="checkbox"/> Otro
Infraestructura Transporte	<input type="checkbox"/> Terminal	<input type="checkbox"/> Taller de Transporte	<input type="checkbox"/> Estación Intermedia	<input type="checkbox"/> Otro
Infraestructura Sanitaria	<input type="checkbox"/> Planta de Tratamiento	<input type="checkbox"/> Relleno Sanitario	<input type="checkbox"/> Instalación de Distribución	<input type="checkbox"/> Otro
Infraestructura Energética	<input type="checkbox"/> Generadora	<input type="checkbox"/> Distribución Eléctrica	<input type="checkbox"/> Comunicaciones	<input type="checkbox"/> Otro
Faena Constructiva	<input type="checkbox"/> Construcción	<input type="checkbox"/> Demolición	<input type="checkbox"/> Reparación	<input type="checkbox"/> Otro
Otro (Especificar)				

**INSTRUMENTAL DE MEDICIÓN**

Identificación sonómetro					
Marca	01dB	Modelo	Fusion 40CD	N° serie	12223
Fecha de emisión Certificado de Calibración	04-10-2019				
Número de Certificado de Calibración	TR-DTE-L-19-PVE-71342				
Identificación calibrador					
Marca	01dB	Modelo	CAL31	N° serie	88150
Fecha de emisión Certificado de Calibración	04-10-2019				
Número de Certificado de Calibración	CE-DTE-L-19-PVE-71342				
Ponderación en frecuencia	A		Ponderación temporal	Lento	
Verificación de Calibración en Terreno	<input checked="" type="checkbox"/> Si		<input type="checkbox"/> No		
<i>Se deberá adjuntar Certificado de Calibración Periódica Vigente para ambos instrumentos.</i>					

**REPORTE TÉCNICO DECRETO SUPREMO N°38/11 DEL MINISTERIO DEL MEDIO AMBIENTE**

Establece Norma de Emisión de Ruidos Generados por Fuentes que Indica

**FICHA DE INFORMACIÓN DE MEDICIÓN DE RUIDO**



**IDENTIFICACIÓN DEL RECEPTOR**

Receptor N°	GC1			
Calle	Duble Almeyda			
Número	N°2390, Depto 402C			
Comuna	Ñuñoa			
Datum	WGS84	Huso	19s	
Coordenada Norte	6.297.113	Coordenada Este	350.745	
Nombre de Zona de emplazamiento (según IPT vigente)	Zona Z-3A PRC Ñuñoa 2019			
N° de Certificado de Informaciones Previas*	<hr/>			
Zonificación DS N° 38/11 MMA	<input type="checkbox"/> I	<input checked="" type="checkbox"/> II	<input type="checkbox"/> III	<input type="checkbox"/> IV
				<input type="checkbox"/> Rural

\* Adjuntar Certificado de Informaciones Previas (Si corresponde, según consideraciones de Art. 8°, D.S. N° 38/11 MMA)

**CONDICIONES DE MEDICIÓN**

Fecha medición	23-09-2020			
Hora inicio medición	0:03			
Hora término medición	0:06			
Periodo de medición	<input type="checkbox"/> 7:00 a 21:00 h	<input checked="" type="checkbox"/> 21:00 a 7:00 h		
Lugar de medición	<input type="checkbox"/> Medición Interna	<input checked="" type="checkbox"/> Medición Externa		
Descripción del lugar de medición	Balcón de domicilio			
Condiciones de ventana (en caso de medición interna)	<input type="checkbox"/> Ventana Abierta	<input type="checkbox"/> Ventana Cerrada		
Identificación ruido de fondo	Ruido de fondo no afecta la medición			
Temperatura [°C]	21,5	Humedad [%]	37,5	Velocidad de viento [m/s]
				0

Nombre y firma profesional de terreno o Inspector Ambiental (IA)	Matías Tapia/Paola Jara	 
Institución, Empresa o Entidad Técnica de Fiscalización Ambiental (ETFA)	SMA	

**Nota:**

- Se deberá imprimir y completar esta página para cada receptor evaluado.
- Se podrán incluir fotografías del punto donde se ubique el sonómetro para la realización de la medición.
- Los datos de Temperatura, Humedad Relativa y Velocidad de viento, corresponderá para mediciones realizadas en el exterior.

**FICHA DE GEORREFERENCIACIÓN DE MEDICIÓN DE RUIDO**

Croquis

Imagen Satelital

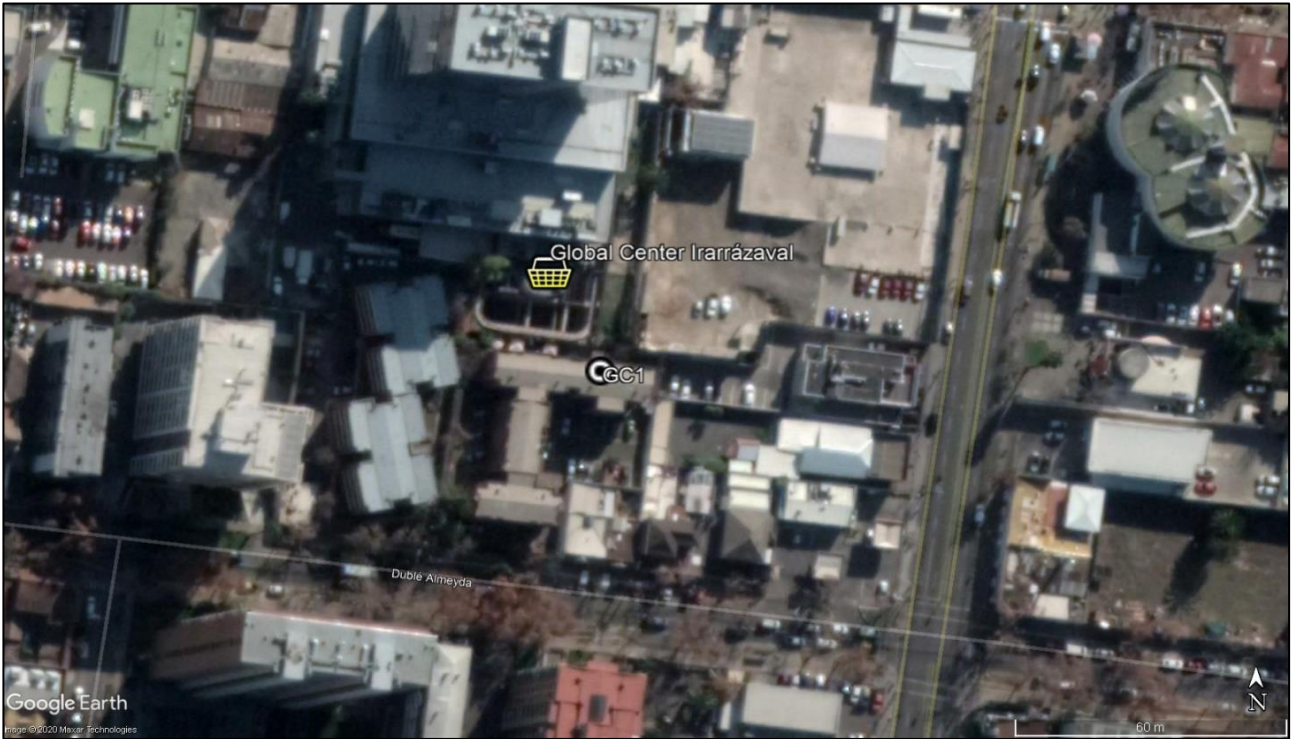

Origen de la imagen Satelital Google Earth

Escala de la imagen Satelital 1:60 m

**LEYENDA DE CROQUIS O IMAGEN UTILIZADA**

Datum		WGS84		Huso		19s	
Fuentes				Receptores			
Símbolo	Nombre	Coordenadas		Símbolo	Nombre	Coordenadas	
	Global Center Irarrázaval	N	6.297.129		GC1	N	6.297.113
		E	350.732			E	350.745
		N				N	
		E				E	
		N				N	
		E				E	
		N				N	
		E				E	

*Se podrán adjuntar fotografías, considerando como máximo una (1) por fuente y dos (2) por lugar de medición.*

**FICHA DE MEDICIÓN DE NIVELES DE RUIDO**

**REGISTRO DE MEDICIÓN DE RUIDO DE FUENTE EMISORA**

Identificación Receptor N°	GC1
<input type="checkbox"/> Medición Interna (tres puntos)	<input checked="" type="checkbox"/> Medición externa (un punto)

	NPSeq	NPSmin	NPSmáx
Punto 1	60,1	59,6	60,6
	60,2	59,7	60,8
	60,5	59,9	61,1

	NPSeq	NPSmin	NPSmáx
Punto 2			

	NPSeq	NPSmin	NPSmáx
Punto 3			

**REGISTRO DE RUIDO DE FONDO**

Ruido de fondo afecta la medición	<input type="checkbox"/> Si	<input checked="" type="checkbox"/> No
Fecha:		Hora:

	5'	10'	15'	20'	25'	30'
NPSeq						

**Observaciones:**

**FICHA DE EVALUACIÓN DE NIVELES DE RUIDO**

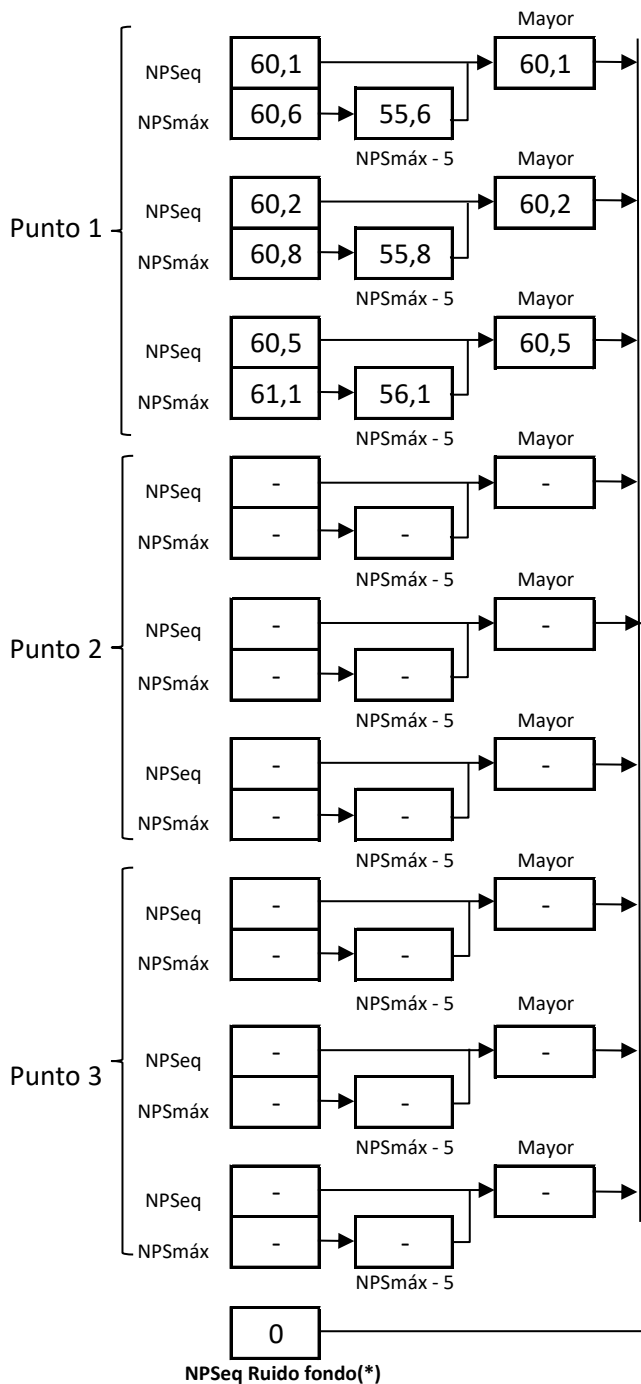

Información del Receptor	
Identificación del Receptor N°	GC1
Indicar Condiciones	
Medición	Exterior
Ventana	No Aplica
Modelación ISO 9613	
No	

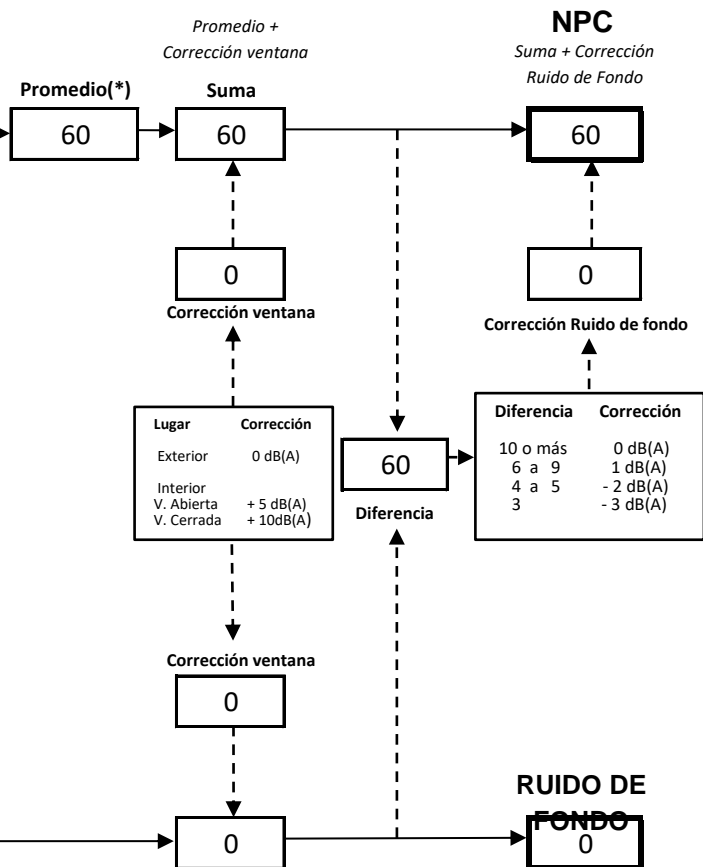

(\*) Aproximar a números enteros

REPORTE TÉCNICO DECRETO SUPREMO N°38/11 DEL MINISTERIO DEL MEDIO AMBIENTE

Establece Norma de Emisión de Ruidos Generados por Fuentes que Indica

**FICHA DE EVALUACIÓN DE NIVELES DE RUIDO**

**TABLA DE EVALUACIÓN**

Receptor N°	NPC [dBA]	Ruido de Fondo [dBA]	Zona DS N°38	Periodo (Diurno/Nocturno)	Límite [dBA]	Estado (Supera/No Supera)
GC1	60	No afecta	II	Nocturno	45	Supera
			Seleccione	Seleccione	-	-
			Seleccione	Seleccione	-	-
			Seleccione	Seleccione	-	-
			Seleccione	Seleccione	-	-
			Seleccione	Seleccione	-	-
			Seleccione	Seleccione	-	-
			Seleccione	Seleccione	-	-
			Seleccione	Seleccione	-	-
			Seleccione	Seleccione	-	-

**OBSERVACIONES**

El ruido emitido corresponde a dispositivos ubicados en techo de construcción ubicada en la parte anterior de edificio Global Center Irrarázaval

**ANEXOS**

N°	Descripción
1	Certificado de Calibración Sonómetro
2	Certificado de Calibración Calibrador Acústico
3	Homologación según IPT

**RESPONSABLE DEL REPORTE (Llenar sólo ETFA)**

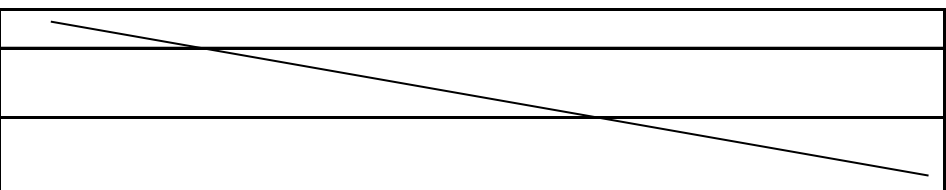
Fecha del reporte	
Nombre Representante Legal	
Firma Representante Legal	



# **FUSION Smart Sound & Vibration Analyzer**

Tests report, according to the IEC 61672-3 : 2013

01dB.com



**01dB**

ACOEM Group

## Tests report

TR-DTE-L-19-PVE-71342

ISSUED FOR :  
SPEVI LTDA  
Malaquias Concha 086  
PROVIDENCIA  
  
750-1552 SANTIAGO  
Chile

**Name and location of the laboratory of tests:**  
**01 dB-Metravib** - 200, Chemin des Ormeaux 69578 Limonest  
Accredited for compliance with ISO/IEC 17025.

### TESTED INSTRUMENT

Designation : Integrator Sound Level Meter

Manufacturer : 01dB

Type : FUSION 40CD      Serial number : 12223

Identification number :

Date of issue : 04/10/2019

This report includes 7 pages

The measurements are performed according to the IEC 61672-3 : 2013, Electroacoustics, -  
Sound level meters – Part 3: Periodic tests.

HEAD OF THE METROLOGY LAB  
**François MAGAND**

04/10/2019

X 

Signé par : MAGAND François

This document may not be reproduced other than in full, except with the prior written approval of the laboratory.



**Identification :**

	Sound level meter	Microphone	Accessories
Manufacturer	01dB	GRAS	
Type	FUSION 40CD	40CD	Windscreen
Serial number	12223	367026	
Firmware version	Application: 2,47 Metrology: 2,12		
<b>Calibrator</b>	<b>01dB CAL31 N° 88150 +</b>		

**Program:**

The Sound level meter has been tested on the following characteristics:

- Self-generated noise\*
- Acoustical signal tests of a frequency weightings
- Electrical signal tests of frequency weightings
- Frequency and time weightings at 1 kHz\*
- Long-term stability\*
- Level linearity\*
- Toneburst response\*
- C-weighted peak sound level\*
- Overload indication\*
- High-level stability\*

\* Tests not covered by the COFRAC accreditation

**Method:**

The instrument is tested in an air conditioned room. The other characteristics are verified with multimeter and generator calibrated in amplitude and in frequency. Some manufacturer's corrections have been applied to account the acoustical effect from the case of the sound level meter and his accessories (IEC 61672-3 : 2013). These corrections are available in the sound level meter user manual.

The reference frequency of the sound level meter is 1000 Hz. The reference sound pressure level of the sound level meter is 94 dB. The sound level meter possesses a single level range.

**Tests conditions:**

Date of tests	04/10/2019
Operator Name	X  <small>04/10/2019</small> <small>Signé par : LEROY Bertrand</small>
Tests instruction	MET.18.INS.083
Static pressure	>95,5 ; <105 kPa
Temperature	23 ± 3 °C
Relative humidity	>25 ; <70 %HR

Instru  
The  
All the  
Resul  
Mentic  
associ  
approx  
Stand  
enviror  
Mentio  
meter.  
Assoc  
See th  
Indica  
Init  
Self-g  
0° + wi  
Microp  
the ele  
Micro

Tests report:  
TR-DTE-L-19-PVE-71342

### Instruments used for tests:

Designation	Manufacturer	Type	Serial number	Identification number
Waveform generator	Hewlett-Packard	33120A	US36028927	APM 1153
Programmable Attenuator	01dB-Metravib	OUT1694	17-10-207	APM 5955
Electrostatic actuator	Gras	14AA+RA0014	181068	APM 5423
Thermometer, hygrometer, barometer	COMET	T7511	18960232	APM 5858

All the measuring instruments are calibrated to national standards with COFRAC certificate of calibration.

### Results:

Mentioned expanded uncertainties correspond to two standard uncertainty types (  $k=2$  ). The measurement value and the associated expanded uncertainty represent the interval which contains the value of measured quantity with a probability of approximately 95 %.

Standard uncertainties are calculated including different uncertainty components, reference standards, instruments used, environmental conditions, calibrated instrument contribution, repeatability, according to ISO/IEC Guide 98-3 (GUM).

Mentioned Maximum Permissible Errors ( M.P.E. ) are the ones defined in the IEC 61672-1 : 2013 for a class 1 sound level meter.

### Associated calibrator

See the calibration certificate n°CE-DTE-L-19-PVE-71342

### Indication at the calibration check frequency\*

Initial indication	Correction	Adjusted indication	Tolerance
( dB )	( dB )	( dB )	( dB )
93,4	-0,5	93,3	+/- 1,0

### Self-generated noise\*

0° + windscreen

Microphone replaced by the electrical input-signal device	Nominal value	Displayed value
	( dB )	( dB )
Leq dBA	< 18	9,0
Leq dBB	< 18	8,2
Leq dBC	< 19	9,1
Leq dBZ	< 22	12,8

Microphone installed	Nominal value	Displayed value
	( dB )	( dB )
Leq dBA	< 21	17,8

**Acoustical signal tests of a frequency weightings**

Level

0° + w

0° + windscreen	Measurement error			Uncertainty (dB)	Maximum Permissible Error (dB)
	C (dB)				
125 Hz	-0,2			0,3	+/- 1,0
1000 Hz	0,0			0,3	+/- 0,7
8000 Hz	-0,6			0,5	-2,5 ; +1,5

**Electrical signal tests of frequency weightings**

0° + windscreen	Measurement error			Uncertainty (dB)	Maximum Permissible Error (dB)
	Z (dB)	A (dB)	C (dB)		
63 Hz	-0,3	-0,3	-0,3	0,4	+/- 1,0
125 Hz	-0,2	-0,4	-0,2	0,4	+/- 1,0
250 Hz	-0,2	-0,3	-0,2	0,4	+/- 1,0
500 Hz	0,0	-0,1	0,0	0,4	+/- 1,0
1000 Hz	0,0	0,0	0,0	0,4	+/- 0,7
2000 Hz	0,3	0,4	0,4	0,4	+/- 1,0
4000 Hz	0,4	0,4	0,4	0,4	+/- 1,0
8000 Hz	0,3	-0,2	-0,2	0,7	-2,5 ; +1,5
16000 Hz	-1,1	-6,5	-6,5	0,7	-16,0 ; +2,5

**Frequency and time weightings at 1 kHz\***

0° + windscreen	Displayed value ( dB )	Measurement error ( dB )	Uncertainty (dB)	M.P.E. (dB)
Lp 94 dBA / 1000 Hz	93,8	Reference		
Lp 94 dBA / 1000 Hz	93,8	0,0	0,1	+/- 0,2
LEQ 94 dBA / 1000 Hz	93,8	0,0	0,1	+/- 0,2
Lp 94 dBC / 1000 Hz	93,8	0,0	0,1	+/- 0,2
Lp 94 dBZ / 1000 Hz	93,8	0,0	0,1	+/- 0,2

**Long-term stability\***

0° + windscreen

Displayed value ( dB )		Measured deviation ( dB )	Uncertainty ( dB )	Maximum Permissible Error (dB)
Initial indication	Final indication			
93,9	93,9	0,0	0,1	+/- 0,1

**Level linearity\***

0° + windscreen

Nominal value ( dB )	Displayed value ( dB )	Measurement error ( dB )	Uncertainty ( dB )	Maximum Permissible Error (dB)
94,0	94,0	0,0	0,3	+/- 0,8
99,0	99,1	0,1	0,3	+/- 0,8
104,0	104,0	0,0	0,3	+/- 0,8
109,0	109,0	0,0	0,3	+/- 0,8
114,0	113,9	-0,1	0,3	+/- 0,8
119,0	118,9	-0,1	0,3	+/- 0,8
124,0	123,8	-0,2	0,3	+/- 0,8
129,0	128,8	-0,2	0,3	+/- 0,8
130,0	129,8	-0,2	0,3	+/- 0,8
131,0	130,9	-0,1	0,3	+/- 0,8
132,0	131,8	-0,2	0,3	+/- 0,8
133,0	132,8	-0,2	0,3	+/- 0,8
134,0	133,9	-0,1	0,3	+/- 0,8
94,0	94,0	0,0	0,3	+/- 0,8
89,0	89,1	0,1	0,3	+/- 0,8
84,0	84,1	0,1	0,3	+/- 0,8
79,0	79,1	0,1	0,3	+/- 0,8
74,0	74,0	0,0	0,3	+/- 0,8
69,0	69,1	0,0	0,3	+/- 0,8
64,0	64,1	0,1	0,3	+/- 0,8
59,0	59,1	0,1	0,3	+/- 0,8
54,0	54,0	0,0	0,3	+/- 0,8
49,0	49,1	0,0	0,3	+/- 0,8
44,0	44,1	0,1	0,3	+/- 0,8
39,0	39,1	0,1	0,3	+/- 0,8
34,0	34,0	0,0	0,3	+/- 0,8
29,0	29,1	0,1	0,3	+/- 0,8
27,0	27,1	0,1	0,3	+/- 0,8
26,0	26,2	0,2	0,3	+/- 0,8
25,0	25,2	0,2	0,3	+/- 0,8
24,0	24,2	0,2	0,3	+/- 0,8
23,0	23,3	0,3	0,3	+/- 0,8

**Toneburst response\***

0° + windscreen

Description	Displayed value		Measurement error	Uncertainty	Maximum Permissible Error (dB)
	( dB )				
135 dB 4000 Hz A Slow 200 ms	127,6		0	0,1	+/- 0,5
135 dB 4000 Hz A Slow 2 ms	108		0	0,1	-3,0 ; +1,0
135 dB 4000 Hz A fast 200 ms	134		0	0,1	+/- 0,5
135 dB 4000 Hz A fast 2 ms	117		0	0,1	-1,5 ; +1,0
135 dB 4000 Hz A fast 0,25 ms	107,9		-0,1	0,1	-3,0 ; +1,0
135 dB 4000 Hz A 1000 200 ms	128		0	0,1	+/- 0,5
135 dB 4000 Hz A 1000 2 ms	108		0	0,1	-1,5 ; +1,0
135 dB 4000 Hz A 1000 0,25 ms	98,9		-0,1	0,1	-3,0 ; +1,0

**C-weighted peak sound level\***

0° + windscreen

Description	Displayed value		Measurement error	Uncertainty	Maximum Permissible Error (dB)
	( dB )				
8000 Hz Complete cycle	135,9		0,5	0,1	+/- 2,0
500 Hz Positive one-half-cycle	135,4		0,0	0,1	+/- 1,0
500 Hz Negative one-half-cycle	135,4		0,0	0,1	+/- 1,0

**Overload indication\***

0° + windscreen

Positive one-half-cycle	Displayed value		Measured deviation	Uncertainty	Maximum Permissible Error (dB)
	( dB )				
Negative one-half-cycle			( dB )	( dB )	
	106,1	106,2	0,0	0,2	+/- 1,5

**High-level stability\***

0° + windscreen

Initial indication	Displayed value		Measured deviation	Uncertainty	Maximum Permissible Error (dB)
	( dB )				
Final indication			( dB )	( dB )	
	136,6	136,6	0,0	0,1	+/- 0,1

### Conclusion

IEC 61672-3 : 2013 Chapter:	Tests	Results
10	Indication at the calibration check frequency*	Compliant
11	Self-generated noise*	Compliant
12	Acoustical signal tests of a frequency weighting	Compliant
13	Electrical signal tests of frequency weightings	Compliant
14	Frequency and time weightings at 1 kHz*	Compliant
15	Long-term stability*	Compliant
16	Level linearity on the reference level range*	Compliant
18	Toneburst response*	Compliant
19	C-weighted peak sound level*	Compliant
20	Overload indication*	Compliant
21	High-level stability*	Compliant

\* Tests and declarations of compliance not covered by the COFRAC accreditation

<b>FUSION user manual</b>	DOC1131 version K August 2017
<b>Type-approval certificate</b>	France: LNE-27092 revision 2 dated 04/04/2017 Deutschland: DE-16-M-PTB-0006 dated 09/28/2016

End of tests report

## Calibration Certificate

CE-DTE-L-19-PVE-71342

ISSUED FOR :  
SPEVI LTDA  
Malaquias Concha 086  
PROVIDENCIA  
  
750-1552 SANTIAGO  
Chile

Name and location of the laboratory of calibration:  
01 dB-Metravib - 200, Chemin des Ormeaux 69578 Limonest  
Accredited for compliance with ISO/IEC 17025.

TESTED INSTRUMENT  
Designation : Sound calibrator

Manufacturer : 01dB

Type : CAL31                      Serial number : 88150

Identification number :

Date of issue : 04/10/2019

This certificate includes 3 pages

The measurements are performed according to the IEC 60942, Electroacoustics, - Sound calibrators.

HEAD OF THE METROLOGY LAB  
François MAGAND

04/10/2019

X 

Signé par : MAGAND François

THIS CERTIFICATE is compliant with THE FD X 07-012 STANDARD DOCUMENTATION  
This document may not be reproduced other than in full, except with the prior written approval of the laboratory.

**Identification :**

Sound calibrator	
Manufacturer	01dB
Type	CAL31
Serial number	88150
Adaptor	

**Calibration Program:**

The calibrator has been calibrated on different characteristics:

- Acoustic pressure level
- Acoustic signal frequency
- Total distortion + noise

**Calibration Method:**

The instrument has been calibrated in a air conditioning room. The characteristics are measured on a measuring chain which used a calibrated acoustic calibrator as reference.

The total distortion + noise is measured using a rejection filter device (distortion factor meter).

**Calibration conditions:**

Date of calibration	04/10/2019
Operator Name	X  <small>Signature: LNE2103 Not valid</small>
Calibration instruction	MET.18.INS.084
Static pressure	>95,5 ; <105 kPa
Temperature	23 ± 3 °C
Relative humidity	>25 ; <70 %HR

**Instruments used for calibration:**

Designation	Manufacturer	Type	Serial number	Identification number
Multimeter	Helwet-Packard	34401A	US36016215	APM 5420
Distortion meter	Helwet-Packard	8903E	3514A01314	APM 5427
Conditioner	GRAS	12 AK	193470	APM 5426
Calibrator	GRAS	42AP	82065	APM 1470
Microphone	GRAS	40AP	340589	APM 6041
Preamplifier	01dB	PRE21A	20931	APM 5889
Thermometer, hygrometer, barometer	COMET	T7511	18960232	APM 5858

All the measuring instruments are calibrated to national standards with COFRAC certificate of calibration.

**Results:**

Mentioned expanded uncertainties correspond to two standard uncertainty types ( k=2 ). The measurement value ar associated expanded uncertainty represent the interval which contains the value of measured quantity with a probab approximately 95 %.

Standard uncertainties are calculated including different uncertainty components, reference standards, instruments i environmental conditions, calibrated instrument contribution, repeatability, according to ISO/IEC Guide 98-3 (GUM).

This calibration certificate guarantees the traceability of calibration measurements to the International System of Uni

Cofrac is signatory of the European co-operation for Accreditation (EA) and of International Laboratory Accreditation Cooperation (Ilac) multilateral agreement. EA signatories recognise the equivalence of calibration certificates issued agreement signatories.

	Nominal value	Displayed value	Measurement error	Expanded uncertainty	Max permitted error
Frequency (Hz)	1000,0	1000,4	0,4	0,1	± 0,1
Level (dB)	94,00	93,81	-0,19	0,15	± 0,15
Total distortion + noise (%)		0,5		0,3	± 0,3

Calibrator user manual	NOT1406 September 2016 G - CAL21 CAL02 User Manual FR_EN
Type-approval certificate	France: LNE-30010 rev. 0 01 Sept. 2015 Deutschland: PTB 21.51 03.01 27 Jan. 2003

**Conclusion:**

The sound calibrator was shown in compliance with the requirements of periodic tests described to the appendix B c 60942: 2017 standard, for the sound calibrator of class 1, concerning the level of acoustic pressure, the frequency a distortion, specified for the conditions of environment in which the tests were realized.

This declaration of compliance isn't covered by the COFRAC accreditation.

End of calibration certificate

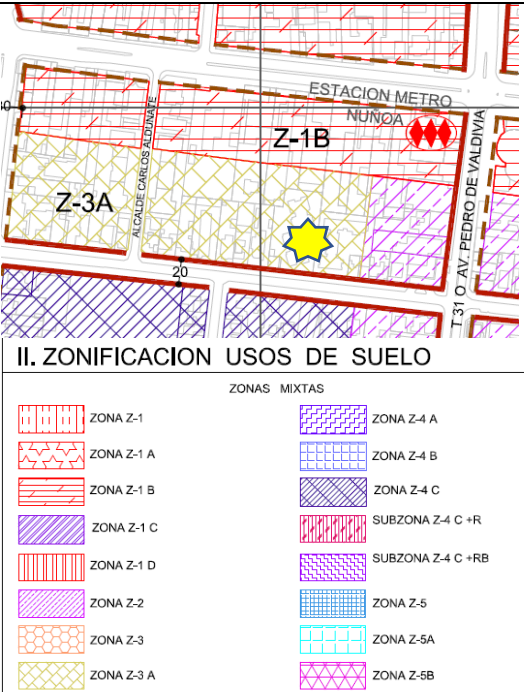

**ANEXO 3: HOMOLOGACIÓN DE ZONA SEGÚN IPT**

Ubicación del receptor, Doble Almeyda N° 2390, Ñuñoa	Zona de acuerdo al IPT	Usos de suelo permitidos ORDENANZA PLAN REGULADOR COMUNAL <sup>1</sup>	Áreas homologada D.S N° 38/11, artículo 6°
 <p><b>II. ZONIFICACION USOS DE SUELO</b></p> <p>ZONAS MIXTAS</p> <ul style="list-style-type: none"> <li>ZONA Z-1</li> <li>ZONA Z-1 A</li> <li>ZONA Z-1 B</li> <li>ZONA Z-1 C</li> <li>ZONA Z-1 D</li> <li>ZONA Z-2</li> <li>ZONA Z-3</li> <li>ZONA Z-3 A</li> <li>ZONA Z-4 A</li> <li>ZONA Z-4 B</li> <li>ZONA Z-4 C</li> <li>SUBZONA Z-4 C +R</li> <li>SUBZONA Z-4 C +RB</li> <li>ZONA Z-5</li> <li>ZONA Z-5A</li> <li>ZONA Z-5B</li> </ul>	Zona Z-3A	Usos de suelo permitidos: -Residencial: Todos los destinos -Área Verde -Espacio Público -Equipamiento	<b>Zona II:</b> aquella zona definida en el Instrumento de Planificación Territorial respectivo y ubicada dentro del límite urbano, que permite además de los usos de suelo de la Zona I, Equipamiento de cualquier escala

<sup>1</sup> Fuente: <https://www.nunoa.cl/images/18/Ordenanza%20Refundida%20PRC%20UOA%20-%20incluye%20MPC%2018.pdf>

# Plano RegularComunal Ñuñoa<sup>2</sup>

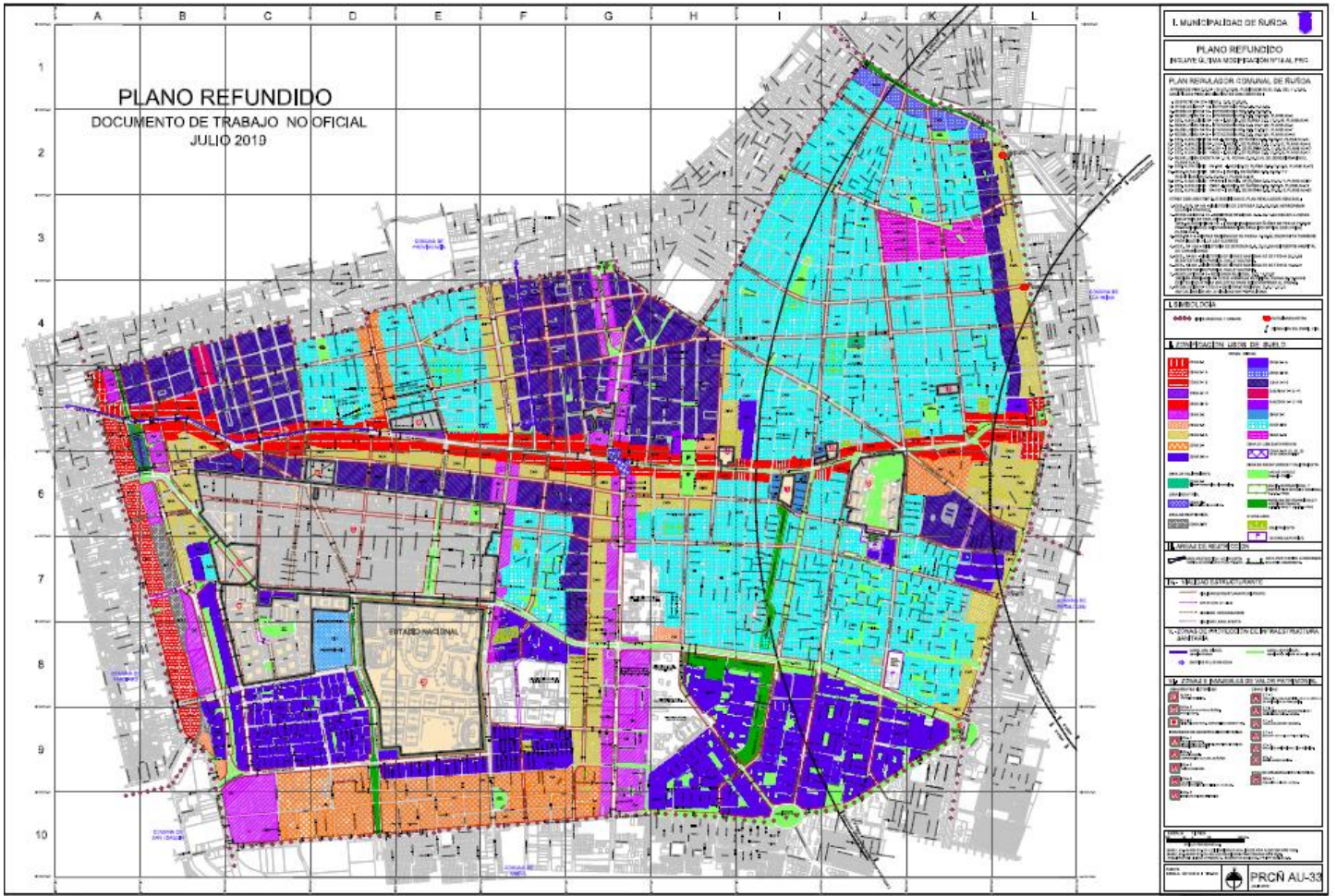

<sup>2</sup> Fuente: <https://www.nunoa.cl/images/18/Plano%20Refundido%20de%20uoa%20PRC%202019%20incluye%20MPC18.pdf>